

XF-416™

Irrigation Controller

Installation Instructions – User Guide



Table of Contents

Specifications	1
Features	1
Controller Components	2-3
Installation Instructions	4-7
<input type="checkbox"/> Battery Installation	4
<input type="checkbox"/> Cabinet Installation	4
<input type="checkbox"/> Connecting Control Valves	5
<input type="checkbox"/> Connecting Pump Start Relay (Optional)	5
<input type="checkbox"/> Connecting Toro Rain Switch (Optional)	5
<input type="checkbox"/> ProgramLink™ (Slaved Controller Installation – Optional)	6
<input type="checkbox"/> Selecting Control Options	7
<input type="checkbox"/> Connecting Power and Equipment Ground Wires	7
Set Clock and Calendar	8
Running a Test Cycle	9
About the Controller Memory	10
Clearing the Controller Memory	10
About Programming the Controller	11
Program Planning Record	11
Helpful Programming Reminders	11
Step A – Set Watering Day Schedule	12-13
<input type="checkbox"/> Calendar Schedule	12
<input type="checkbox"/> Interval Schedule	13
<input type="checkbox"/> Odd Days, Even Days or Off Mode	13
Step B – Set Program Start Time(s)	14
Step C – Set Station Run Time	15
Assign Pump/Master Valve Operation	16
Watering Operation Controls	17
<input type="checkbox"/> To Pause Watering	17
<input type="checkbox"/> To Resume Watering (When Paused)	17
<input type="checkbox"/> To Cancel Watering	17
<input type="checkbox"/> To Advance Through Watering Program(s)	17
<input type="checkbox"/> To Modify Station Run Time	17
Manual Control Operations	18-19
<input type="checkbox"/> To Operate Selected Station(s)	18
<input type="checkbox"/> To Operate Selected Program(s)	19
<input type="checkbox"/> To Operate All Programs	19
Season Adjust	20
<input type="checkbox"/> Program Adjust	20
<input type="checkbox"/> Global Adjust	20
Off and Rain Delay Modes	21
Station Control Modules	22
<input type="checkbox"/> Installing A Control Module	22
<input type="checkbox"/> Removing A Control Module	22
Program Planning Charts	23-24
Troubleshooting	25
Quick Reference	Back Cover

Specifications

Transformer Type: Internally mounted.

Transformer Input: 120 VAC, 60 Hz, 60 Watts (max.) or 220/240 VAC, 50 Hz, 70 Watts (max.)

Transformer Output: 24 VAC, 50/60 Hz, 1.7 Amps

Station Output (maximum load) : 0.5 Amp @ 24 VAC 50/60 Hz (holding) @ 140° F (60° C)

Pump/Master Valve Output (maximum load): 0.35 Amp @ 24 VAC 50/60 Hz (holding) @ 140° F (60° C)

Maximum Combined Output: (2 Stations plus Pump/MV), 1.35 Amps @ 24 VAC @ 140° F (60° C)

Operating Temperature Range: 14° F – 140° F (-10° C – 60° C)

Circuit Breaker: 2.0 Amp, press to reset – protects 24 VAC Output

Secondary Surge Protection: Normally Open relay contact, one per output terminal

Fuse: 250 Volt 0.5 Amp, fast blow – protects AC Return

Battery Type and Back-Up Duration: 9-Volt Alkaline – 72 hours or 9-Volt NiCd – 10 Hours

Cabinet: Wall mount, weather resistant, 14-⁷/₈" H x 11-¹/₄" W x 3-³/₄" D (37.8 cm H x 28.6 cm W x 9.5 cm D)

Wiring Access Holes: Power/Ground Wiring - ⁷/₈" (22 mm) for ¹/₂" conduit adapter
Control Wiring - 1-³/₈" (35 mm) for 1" conduit adapter

Features

Modular Design: Plug-in control modules for station and pump/master valve output. 4-station control modules provide convenient upgrade to 12 or 16 stations.

4 Independent Watering Programs (P1 – P4): Provide the scheduling flexibility required for the most demanding landscape designs. Program features include: Watering days selectable by 14-day calendar, 1 to 14 day Interval or Odd/Even numbered days. Up to 6 program start times per day with up to 3 three repeat cycles per start. Station run time duration from 0 (Off) to 120 minutes in 1-minute increments or 2 to 12 hours in 5-minute increments. Option provided for simultaneous operation of any two programs.

Self-Prompting, Multi-Lingual Display: Large, easy-to-read liquid crystal display with descriptive prompts and icons. Word prompts are language-selectable in English, Spanish, French, Italian and German.

Vandal and Weather-Resistant Cabinet: High-impact plastic construction with locking, insulated cover. Cabinet design features hinged control panel for easy access to internal components, knock-out wiring access plugs on base and back panels and isolated AC wiring compartment with safe, convenient terminal strip connection.

Battery Back-Up: Accepts 9-Volt Alkaline or NiCd battery to maintain real-time clock/calendar and operating information during power interruptions. Enables controller to be fully programmed prior to connecting AC power. Switch-controlled battery charging circuit maintains NiCd battery at peak charge. Displayed battery icon signals low voltage condition.

Test Cycle: Provides 1 to 15 minute operation on each station for one cycle. Perfect for checking a new installation or whenever a short, temporary watering cycle is needed.

Rain Switch Ready: Built-in sensor port with manual override switch for the connection and control of a Toro Rain Switch (model 850-74) or other normally-open rain sensing devices.

Pump/Master Valve Assignment: Enables pump or master valve operation to be assigned On or Off per station as required.

Season Adjust: Automatically scales the programmed run time of each station down or up in 1% increments from 10% to 250% of set value to easily compensate for seasonal watering demand. **Program Adjust** modifies run time of all stations within a program; **Global Adjust** modifies run time of all stations in all programs.

Rain Delay: Suspends watering operation as needed from 1 to 7 days. Display shows days remaining until watering resumes.

ProgramLink Operation: Enables two XF - 416 XF controllers to be linked together electronically for the sequential operation of watering programs from one controller to the other. Provides synchronized operation of up to 32 stations (16 stations per controller).

Manual Control: Enables manual operation of selected stations, selected programs or all programs as needed to supplement the automatic watering schedule.

Controller Components

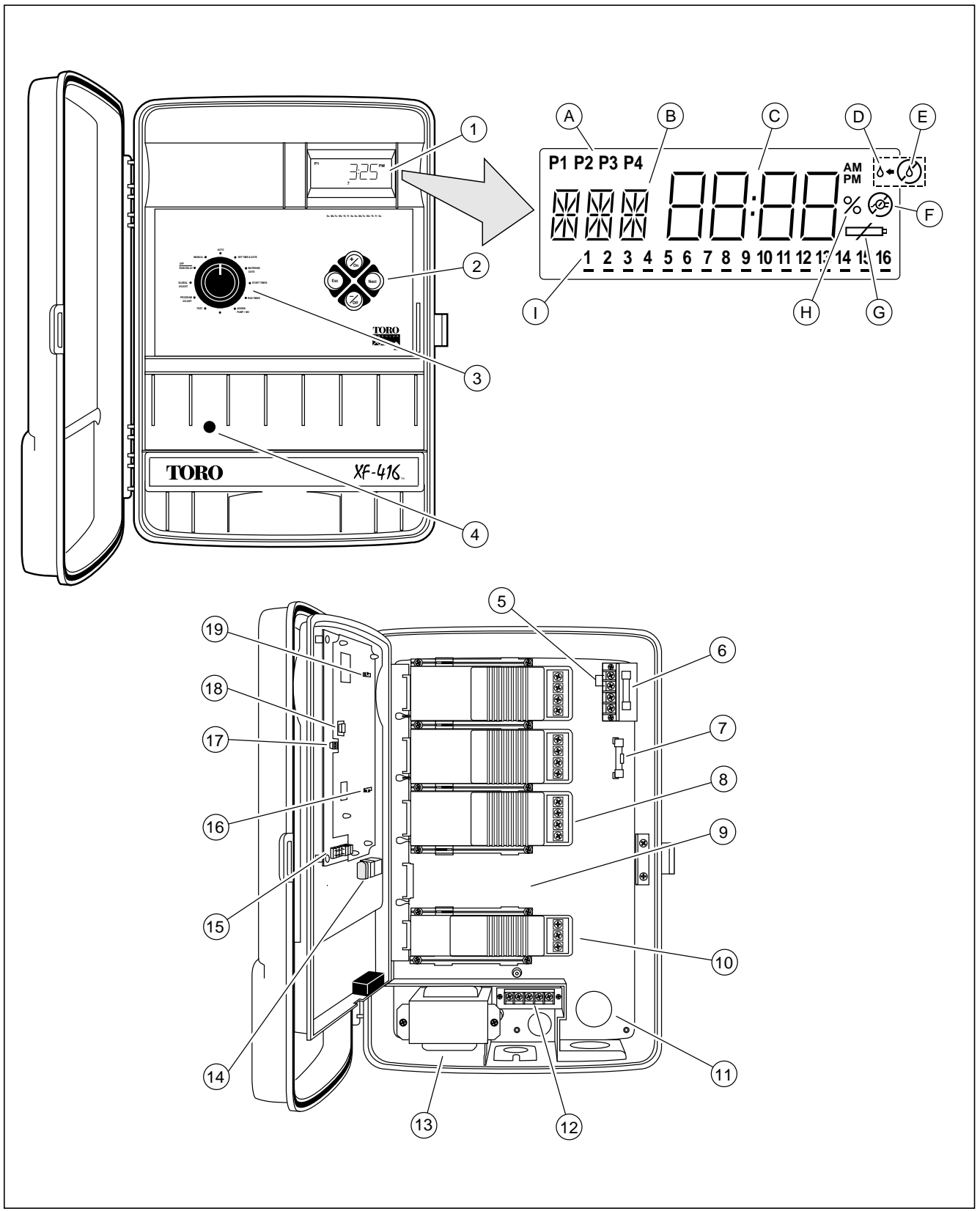

Controller Components

1 - LCD Display

- A** - Program number indicators.
- B** - Display prompts for various programming and operating functions.
- C** - Display prompts and time indicators for various programming and operating functions.
- D** - Watering On or watering interrupted (when flashing).
- E** - Watering operations canceled.
- F** - AC power disconnected (controller operating on battery back-up).
- G** - Low battery voltage - replace battery.
- H** - Percentage indicator for season adjust value.
- I** - Number indicators for days, stations and program start times.

2 - Control Buttons

+ / On - Increases time display, steps forward through program elements, selects On, watering days and active stations.

- / Off - Decreases time display, steps backward through program elements, selects Off, omits watering days and stations.

Next - Selects next portion of program information. Resumes a paused watering operation.

Esc (Escape) - Press once to return to beginning of programming procedure or pause a watering operation. Press twice to exit a programming procedure or cancel a watering operation.

3 - Control Dial

Auto - Normal dial position for automatic and manual watering operations.

Time & Day - Accesses clock and calendar mode to change or review current settings.

Watering Days - Accesses programming mode to set or review program watering day schedule.

Start Times - Accesses programming mode to set or review program start times.

Run Times - Accesses programming mode to set or review station run times.

Assign Pump/MV - Accesses programming mode to assign pump/master valve operation On or Off for each station.

Test - Accesses Test program for quick check of system operation.

Program Adjust - Accesses programming mode to change run time of all stations in a program by a percentage value from 10% – 250%.

Global Adjust - Accesses programming mode to change run time of all stations in all programs by a percentage value from 10% – 250%.

Off / Rain Delay - Selects Off and Rain Delay modes to suspend system operation.

Manual - Accesses manual operation modes.

4 - Circuit Breaker - Rated @ 2.0 Amps, protects 24 VAC output. Push to reset if tripped.

5 - Rain Switch Connection Terminals - For connection of Toro Rain Switch or other normally open rain sensing device.

6 - Fuse - Rated 0.5 Amps, protects controller's electronic circuitry.

7 - Spare 0.5 Amp Fuse

8 - Station Output Control Module - Plug-in module with connections for 4 station outputs.

9 - Expansion Slot - Enables installation of additional 4-station control module.

10 - Pump/Common Output Control Module - Plug-in module with connections for pump/master valve and two 24 VAC commons.

11 - Wiring Access Plugs - Knock-out plugs on base and back panel for ½" and 1" conduit adapters.

12 - AC Power Terminal Strip - Enables easy, safe connection of AC wiring for 120 VAC 60 Hz or 220/240 VAC 50 Hz power source.

13 - Transformer - 120 VAC 60 Hz or 220/240 VAC 50 Hz input, 24 VAC 50/60 Hz output.

14 - 9-Volt Battery - Alkaline or NiCd, supplies back-up power to maintain real time clock operation during an AC power interruption. Enables controller to be programmed prior to installation.

15 - Control Option Jumpers - Enables easy selection of optional control features. See "Selecting Control Options", page 7 for details.

16 - Sensor On/Off Switch - Controls sensor input to enable or disable Rain Switch operation.

17 - ProgramLink Control Cable Connection Port - Connection port for slaved controller installation. See "ProgramLink – Slaved Controller Installation", page 6 for detailed information.

18 - Multi-Program Option Jumper - Enables simultaneous operation of two programs. See "Selecting Control Options", page 7 for details.

19 - Battery Switch - Two-position switch for Alkaline or NiCd battery installation. NiCd position activates battery charging circuit.

Installation Instructions

Battery Installation

The XF - 416 utilizes a 9-Volt battery to maintain current time/date and controller operating information during an AC power failure. The battery also enables the controller to be fully programmed prior to installation. To take advantage of this feature, skip ahead to “Set Clock and Calendar” on page 8 after installing the battery.

Either an Alkaline or a NiCd battery can be installed. The Alkaline battery provided with the controller will last for approximately 72 hours of continuous duty. A fully charged NiCd battery will last for approximately 10 hours of continuous duty. Even though the NiCd battery has a shorter duty cycle, it is a better choice for areas with frequent power failures, since it is continuously held at peak charge by the controller's charging circuit. If the battery is not installed, or its voltage is below minimum requirements, the low battery voltage indicator will be displayed.

Note: The battery will not operate the station/pump outputs; AC power must be connected.

1. Unlock and open controller cover.
2. Carefully swing hinged control panel open, grasping it from the lower right side edge.
3. Locate battery clip and attach it to battery terminals. Place battery into holding bracket as shown in **Figure 1**.
4. Set battery switch to Alkaline or NiCd position according to type of battery installed. See **Figure 1**.

Caution: The battery switch must be properly set for the type of battery installed. Switch set in NiCd position can cause an Alkaline battery to overheat and leak, possibly damaging the controller.

5. Clock time display will begin flashing. To halt flashing, press any control button.

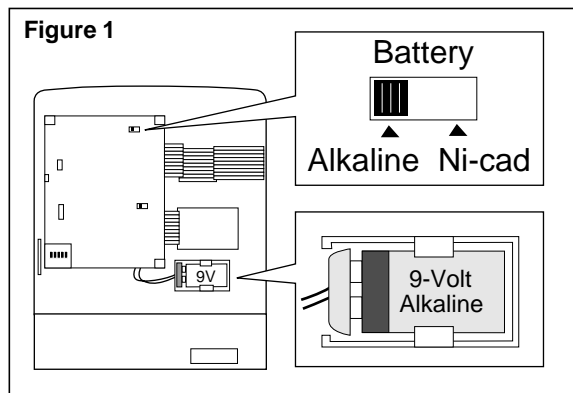

Cabinet Installation

1. Remove lower access cover secured with a single screw.
2. Carefully remove $\frac{7}{8}$ " (22 mm) and $1\text{-}\frac{3}{8}$ " (35 mm) wiring access knock-out plugs from base or back of cabinet as required. See items A and B in **Figure 2**.
3. Using a small screwdriver or punch, remove lower mounting screw hole plugs as required. See item C in **Figure 2**.
4. To expose top mounting hole, remove top station control module. Slide locking tab to the left. Slide module carefully to the right; disengaging it from PC board receptacles and slotted openings in guide rails. See **Figure 3**.

Note: If installing the controller on drywall or masonry, install the appropriate screw anchors as necessary.

5. Using a #10 x $1\text{-}\frac{1}{2}$ " (38 mm) wood screw (provided) install top mounting screw into wall at eye level leaving $\frac{1}{2}$ " (12 mm) of screw exposed.
6. Hang controller on screw using keyhole shaped slot.
7. Install lower mounting screws and tighten all screws securely.
8. Carefully position control module into slotted guide rails. Slide module to the left; plugging it securely into PC board receptacles.
9. Install optional $\frac{1}{2}$ " conduit for AC /Ground wiring and 1" conduit for field wiring at this time.

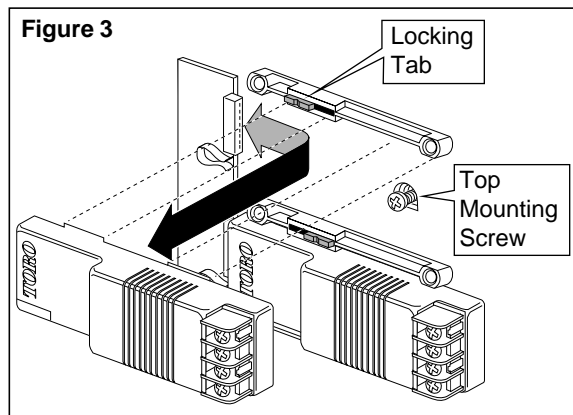
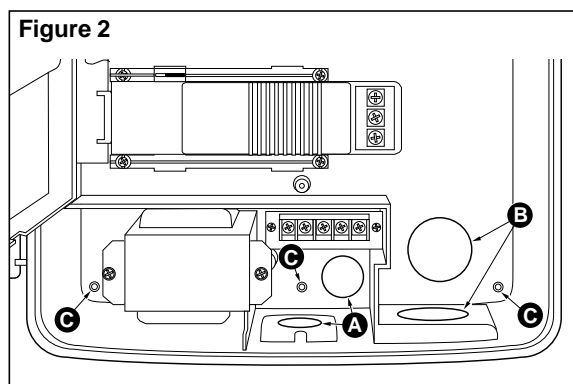

Connecting Control Valve Wiring

1. Using waterproof splices, attach a separate control wire to either lead of each control valve solenoid. Attach one common wire to remaining lead of all valve solenoids.
2. Label control wires and common wire to facilitate connection to controller. Route wires into controller cabinet through 1" conduit.
3. Secure valve control wires to station control modules in desired operating sequence. Secure common wire to either common terminal of pump/master valve control module. See **Figure 4**.
4. If installing an optional master valve, connect one solenoid lead to Pump terminal and remaining lead to Common terminal or Valve Common wire.

Note: Valve load per station must not exceed 0.5 amps @ 24 VAC. If connecting more than one control valve per station, ensure total amperage load (including pump/master valve) does not exceed 1.35 amps (holding). Circuit breaker will be tripped if maximum load is exceeded.

Figure 4

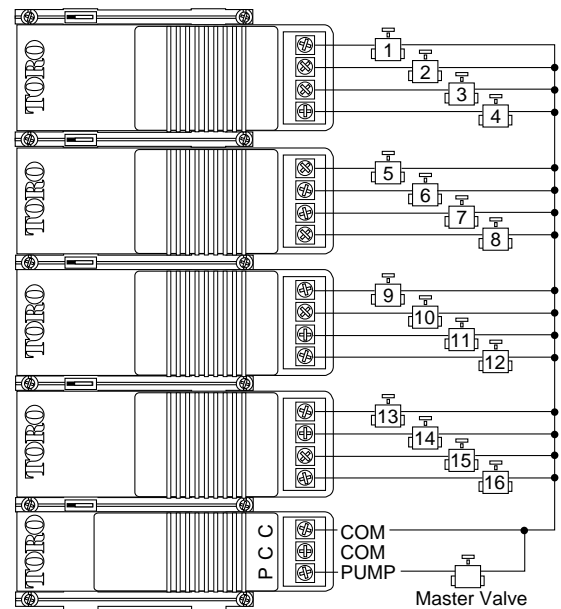

Connecting Pump Start Relay Wiring (Optional)

1. If automatic pump start installation is required, refer to applicable wiring diagram in **Figure 5** and install accordingly.

Note: Pump/master valve load must not exceed 0.35 amps @ 24 VAC.

Connecting Toro Rain Switch (Optional)

1. Route wire cable from Toro Rain Switch (model number 850-74) into controller through 1" conduit.
2. Connect 18 gauge copper wire and 24 gauge silver wire to sensor terminals as shown in **Figure 6**. Cut off two remaining cable wires at end of cable insulation.
3. Set Sensor Switch position as required. Position switch On to enable Rain Switch or Off to disable Rain Switch.

Figure 6

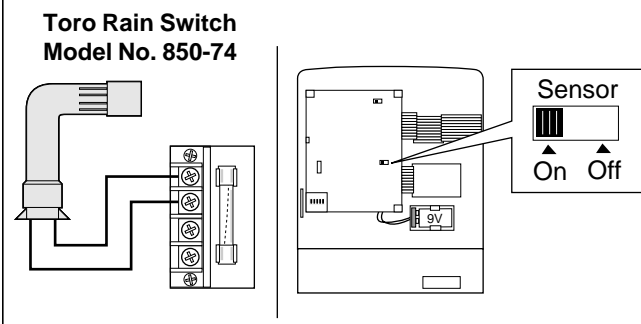
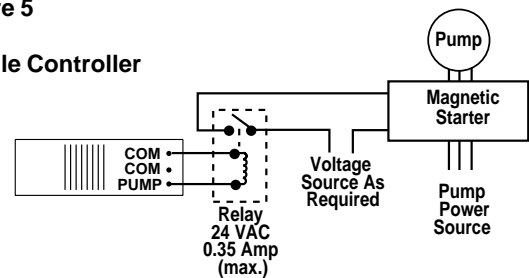
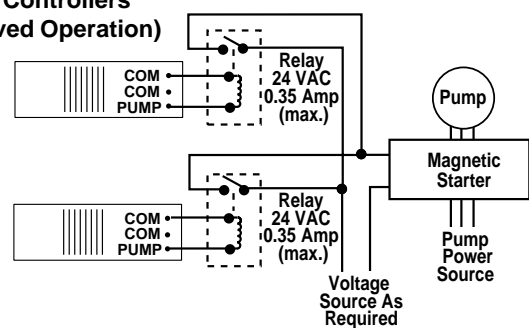

Figure 5

Single Controller



Two Controllers (Slaved Operation)



Pressure Switch With Controller Override

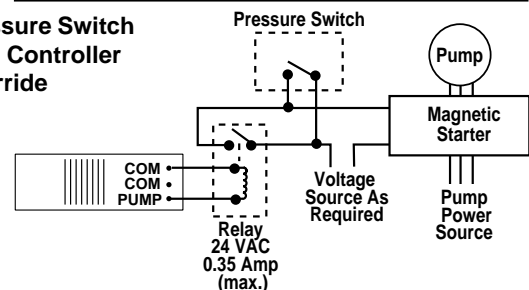

ProgramLink™ – Slaved Controller Installation (Optional)

The ProgramLink feature enables two XF - 416 controllers to be slaved (linked) together electronically for the sequential operation of watering programs synchronized from one controller to the other.

The controllers are connected via a cable assembly attached to the back of each control panel. The slaved controller is designated by the removal of control option Jumper #3. Once the jumper is removed, a programming option is made available to the slaved controller which enables each watering program to be automatically started by the master controller as desired.

During operation, the master controller sends a start command to the slaved controller at the end of each watering program cycle. If programmed to do so, the slaved controller will automatically respond by starting the watering cycle of the matching program number. For example: The slaved control option has been assigned (On) for Program 1 of the slaved controller. As the last station in Program 1 of the master controller finishes operation, Program 1 watering cycle of the slaved controller will start automatically.

It is important to note that a slaved controller has the option of operating independently as needed. The slaved operating mode can be assigned On or Off for any program (P1 – P4) and additional start times can be assigned to any program as required.

Installing Cable Assembly

1. Install controllers within close proximity of one another.
2. Route cable assembly between controllers and connect to receptacles provided on the control panel PCB. Dress cable through retaining clips located beneath large ribbon conductor cable.
See **Figures 7** and **8**.

Note: Cable plugs are keyed to fit receptacles in one direction only. Do not force plugs into receptacles.

3. Position control option Jumper #3 to determine master and slaved controller as shown in **Figure 8**.

Note: The procedure for assigning slaved operation of program(s) is provided in Step B - Set Program Start Time(s) on page 14.

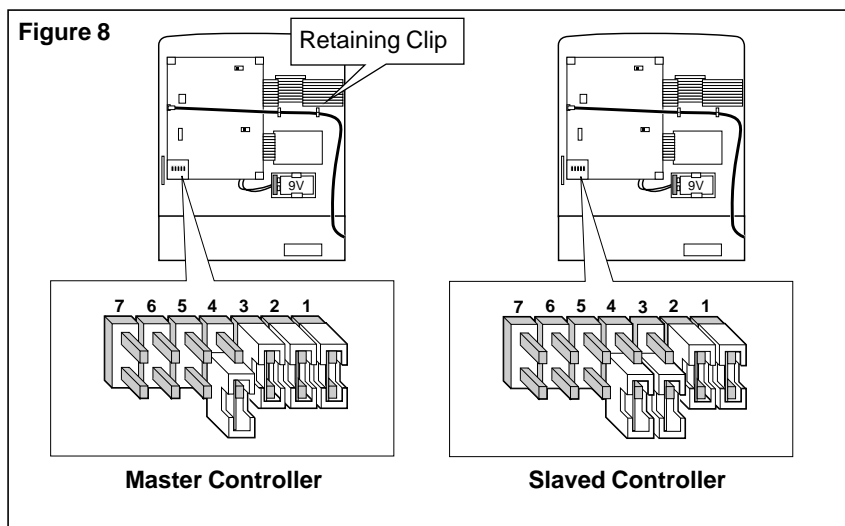
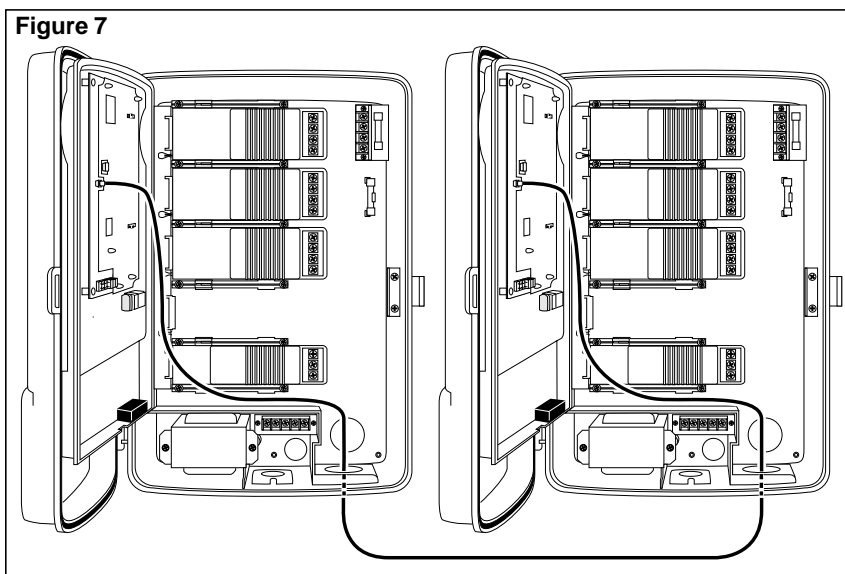

Selecting Control Options

Removable jumpers are provided which enable various control options to be easily selected. The jumpers are located on the back of the control panel as indicated in **Figure 9**. The change caused by the removal or installation of a jumper will become effective immediately. Disconnecting the battery or removing power to the controller is **not** required. The control options provided are as follows:

Jumper 1 - Installed - Selects 12-hour (a.m./p.m.) clock mode.

Removed - Selects 24-hour clock mode.

Jumper 2 - Installed - Provides a 15 second delay after pump start and between station output sequence.

Removed - 15 second delay Off.

Jumper 3 - Installed - Designates "Master" controller.

Removed - Designates "Slaved" controller.

Note: Positions 4 – 7 are provided for the selection of alternate language formats for some of the display prompts, i.e., calendar month. If a jumper is not installed in one of these positions, English prompts are selected. One jumper is provided for the selection of an alternate language as follows:

Position 4 - Jumper installed selects Spanish display prompts.

Position 5 - Jumper installed selects French display prompts.

Position 6 - Jumper installed selects German display prompts.

Position 7 - Jumper installed selects Italian display prompts.

Multi-Program Jumper - Installed - Allows only one watering program to operate at a time.

Removed - Enables any two watering programs to operate simultaneously.

Figure 9

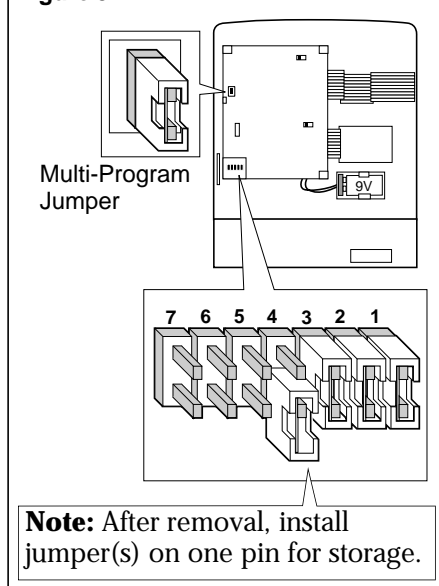

Connecting Power and Equipment Ground Wires



WARNING

ALL ELECTRICAL CONNECTIONS MUST BE MADE IN COMPLIANCE WITH ALL APPLICABLE ELECTRICAL CODES. DISCONNECT POWER TO CONTROLLER AT SOURCE PRIOR TO MAKING ANY WIRE CONNECTIONS. FAILURE TO COMPLY MAY RESULT IN SERIOUS INJURY AND/OR EQUIPMENT DAMAGE.

1. Route insulated three-core power/ground cable from 120 VAC 60 Hz or 220/240 VAC 50 Hz power source into transformer compartment through $\frac{1}{2}$ " conduit.

2. For **120 VAC** input, refer to **Figure 10** and connect wires to terminals as follows:

- EARTH - Equipment ground (bonded to ground)
- Terminal 1 - Neutral
- Terminal 2 - 120 VAC 60 Hz Line

For **220/240 VAC** input, refer to **Figure 11** and connect wires to terminals as follows:

- EARTH - Equipment ground (bonded to ground)
- Terminal 1 - Neutral
- Terminals 2 and 3 - Install jumper wire (use appropriate wire size)
- Terminal 4 - 220/240 VAC 50 Hz Line

3. Install lower access cover.

4. Apply power to controller.

Figure 10 120 VAC

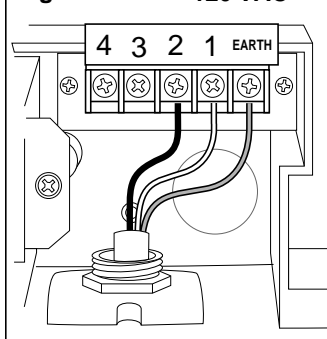
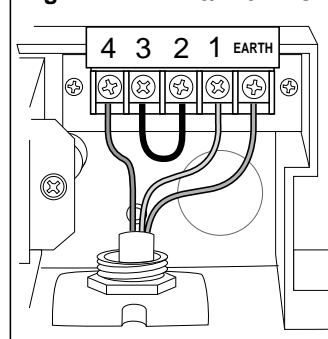

Figure 11 220/240 VAC



Set Clock and Calendar

Synchronizing the controller's clock and calendar to the current time and date is an important first step in preparing the controller for automatic operation. The actual starting times and days that automatic watering will take place are based on the information entered during this procedure.

To set current time and date:

1. Turn the Control Dial to the **TIME & DATE** position.
 - The clock time display will begin flashing.
2. Press the **+On** or **-Off** button to increase or decrease the clock display until the current time is shown.
 - Press and hold either button for more than three seconds to change the display rapidly.
 - Observe for the correct a.m./p.m. reference. (Applies to 12-hour clock mode only.)
3. Press the **Next** button.
 - The calendar date will be displayed and the month will begin flashing.
4. Press the **+On** or **-Off** button as needed to display the current month.
5. Press the **Next** button.
 - The calendar day will begin flashing.
6. Press the **+On** or **-Off** button as needed to display the current calendar day.
7. Press the **Next** button.
 - The calendar year will begin flashing.
8. Press the **+On** or **-Off** button as needed to display the current calendar year.
9. Press the **Next** button.
 - The current day number of the 14-day (two-week) cycle will begin flashing.
10. Press the **+On** or **-Off** button as needed to place the current day number within week 1 or week 2 of the two-week cycle.
11. Return the Control Dial to the **AUTO** position.
 - The current time and day number will be displayed.
 - The colon (:) in the clock time display will flash continuously when displaying the time and day.

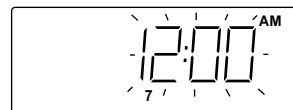

Current clock setting.

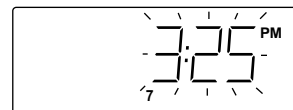

Current time set. Example: 3:25 PM.

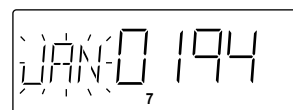

Advance to calendar month display.

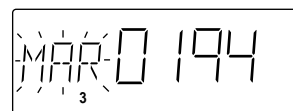

Current month set. Example: March.

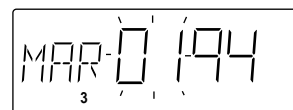

Advance to calendar day display.



Current calendar day set. Example: March 6.

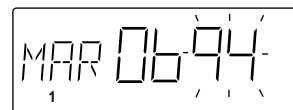

Advance to calendar year display.

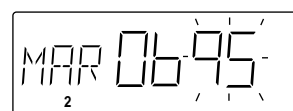

Current year set. Example: 1995.

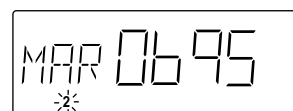

Advance to current day of two-week cycle.

Su Mo Tu We Th Fr Sa Su Mo Tu We Th Fr Sa

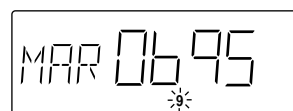

Current day of 2-week cycle set. Example: Monday of week 2.

Su Mo Tu We Th Fr Sa Su Mo Tu We Th Fr Sa

Running A Test Cycle

The Test Cycle feature enables you to quickly verify proper controller timing function and operation of each watering station. A temporary run time of 1 – 15 minutes is assigned to all stations selected for the test. The test cycle will operate each station in sequence for the selected run time. When the test concludes, the display will return to the current time and day.

Note: Additional manual control features become available when the controller test watering cycle is in progress. Refer to “Watering Operation Controls” on page 17 once watering has started.

To operate the test cycle:

1. Turn Control Dial to **TEST** position.
 - TST will be displayed and station run time (1 – 15 minutes) will begin flashing.
 - All station numbers will be displayed and underlined (selected to operate).

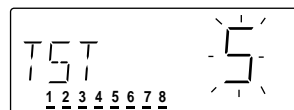

Test Cycle mode selected.
Example: 5 minutes station run time set.

Note: If the station count displayed does not correspond with the number of station modules installed, refer to “Station Control Modules” on page 22 to verify proper module installation.

2. Press the **+On** or **-Off** button as needed to increase or decrease the station run time (1 – 15 minutes).
 - Press and hold either button for more than three seconds to change the display rapidly.

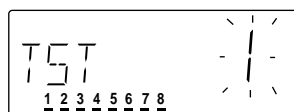

Example: Station run time set to 1 minute.

3. Press the **Next** button.
 - Station number 1 will begin flashing.

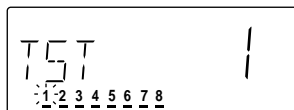

Advance to station select. Station 1 flashing.

Note: If you wish to test only selected stations, continue at step 4. If you wish to test all stations, press the **Next** button again to start the test cycle, then **return the Control Dial to the AUTO position**.

4. Select the station(s) as follows:

To select the station number which is flashing, press the **+On** button.

- The station number will remain underlined and the next station number will begin flashing.

To omit the station number which is flashing, press the **-Off** button.

- The next station number will begin flashing.

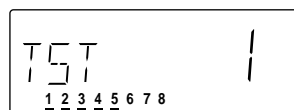

Example: Stations 1 – 5 selected to operate. Stations 6 – 8 omitted from test.

5. Repeat step 4 until only the station numbers you wish to operate during the Test Cycle are underlined.
6. Press the **Next** button.
 - The first selected station in numerical sequence will begin watering.
 - The “Watering On” symbol will be displayed.
7. Return the Control Dial to the **AUTO** position.
 - TST and the remaining station run time will be displayed.
 - The operating station number will begin flashing.
 - All remaining stations will operate in sequence.
 - The display will return to the current time and day when the test cycle is finished.

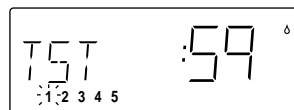

Control Dial in Auto position.
Station 1 On, 59 seconds run time remaining.

To terminate the test cycle:

To terminate the Test Cycle operation and return to the time and day display, **ensure the Control Dial is turned to the AUTO position**, then press the **Esc** button **two** times.

About The Controller Memory...

The XF - 416 can be programmed when powered by either a 9-Volt battery or AC line voltage. As the watering program information, i.e., watering days, cycle start times and station run times, is selected, it is being stored in a computer memory chip. The chip will retain the program information indefinitely when sustained by a power source or for a minimum of one year without power. If the controller has a fully charged battery installed and an AC power interruption occurs, the controller will continue to keep current time and operate as programmed, however no watering will take place, as 24 VAC is required to open the control valves. If the battery is discharged or is not installed and an AC power interruption occurs, all controller operation will cease, however, the watering program information will remain intact. When power is restored, the clock time and date will default to 12:00 a.m., January 01, 1994. Automatic operation will occur as programmed but will not be synchronized with real time. To restore operation, simply install a new battery, then reset the clock and calendar to current time and date.

When shipped from the factory, the watering program memory is clear. If the controller has been previously programmed and you wish to erase or clear the memory, refer to "Clearing the Controller Memory" below for this procedure.

Clearing The Controller Memory

NOTICE! The following procedure will erase all user-defined program information (except current time and date). Please note that it is not possible to retrieve this data once it has been erased!

Procedure:

1. Turn the Control Dial to the **OFF / RAIN DELAY** position.
 - OFF will be displayed and the "no watering" symbol will begin flashing.
2. Press and hold the **+On and -/Off** buttons until CLR (clear) is displayed.
3. Return the Control Dial to the **AUTO** position.



Off mode selected.

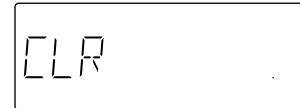

Controller Memory cleared.

Step A - Set Watering Day Schedule

The watering day schedule determines which day(s) an automatic program will operate. Each program can utilize one of the following watering day scheduling modes:

Calendar schedule, which enables watering days to be selected by specific days (Sunday through Saturday) of a two-week (14 day) cycle.

Interval schedule, which establishes watering days based on how often watering must occur, without regard to actual calendar days. The available interval schedules range from 1 (every day) to 14 (every 14th day).

Odd day mode for watering on all odd numbered calendar days.

Even day mode for watering on all even numbered calendar days.

Off mode to prevent the automatic operation of any program as required. Placing a program in the OFF mode removes all active watering days from the program but does not affect other portions of the program operating data which may be entered, such as station run time or start times. This effectively prevents automatic operation of the program but enables it to be operated manually as needed. The program will remain in the OFF mode until a Calendar, Interval, Odd or Even watering day schedule is selected. Any unused programs should be placed in the OFF mode.

Use **one** of the following procedures to set a watering day schedule:

Calendar Schedule

- Turn the Control Dial to **WATERING DAYS** position.
- Program P1 indicator will begin flashing. To select program P2, P3, or P4, press the **+On** or **-Off** button until the desired program indicator begins flashing.
 - The current watering day mode (CAL, INT, ODD, EVN or OFF) for the program selected will be displayed.
- Press the **Next** button.
 - The watering day mode will begin flashing.
- Press the **+On** or **-Off** button (if needed) to select CAL (Calendar).
 - Day numbers 1 – 14 are displayed and the current watering days are underlined.
- Press the **Next** button.
 - Day number 1 will begin flashing.
 - If day number 1 is set to water, the number is underlined and On is displayed.
 - If day number 1 is not set to water, the number is not underlined and Off is displayed.
- Set the watering day schedule as follows:

For watering on the day number (flashing), press the **+On** button.

 - The next day number will begin flashing. On or Off is displayed for that day number.

For no watering on the day number (flashing), press the **-Off** button.

 - The next day number will begin flashing. On or Off is displayed for that day number.
- Repeat step 6 to set all 14 days as needed.
- Return the Control Dial to the **auto** position.

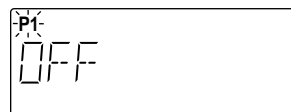

Program 1 selected. This program is currently set to Off mode.

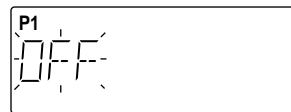

Advance to watering day mode.

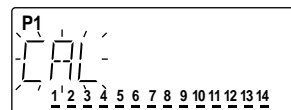

Select Calendar watering day mode.

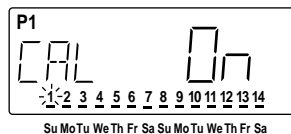

Current watering day schedule for this program – water everyday.

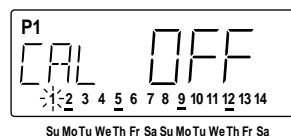

Watering day schedule set. Example: Watering set for Monday and Thursday of both weeks.

Interval Schedule

1. Turn the Control Dial to the **WATERING DAYS** position.
2. Program P1 indicator will begin flashing. To select program P2, P3, or P4, press the **+/On** or **-/Off** button until the desired program indicator begins flashing.
3. Press the **Next** button.
 - The current watering day mode (CAL, INT, ODD, EVN or OFF) will begin flashing.
4. Press the **+/On** or **-/Off** button as needed until INT (Interval mode) is flashing.
5. Press the **Next** button.
 - The current interval number (1 – 14) will begin flashing and all numbers preceding the interval number are displayed.
 - The interval starting day is underlined.
6. Press the **+/On** or **-/Off** button as needed until the desired interval number is displayed and flashing.
 - 1 = every day 2 = every other day 3 = every third day, etc.
7. Press the **Next** button.
 - The number underline will begin flashing.
8. Press the **+/On** or **-/Off** button as needed to place the underline beneath the initial starting day (watering day) of the interval.
 - 1 = today 2 = tomorrow 3 = two days from today, etc.
9. Return the Control Dial to the **AUTO** position.

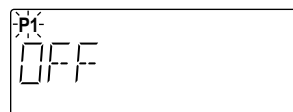

Program 1 selected. Current watering day mode is Off.

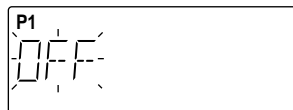

Advance to watering day mode.

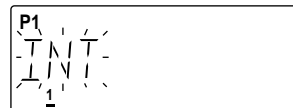

Select Interval watering day mode.

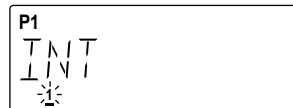

Current Interval schedule for this program.
Example: Water everyday (1).

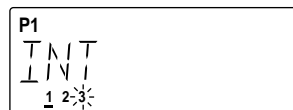

Interval selected
Example: Water every third day (3).

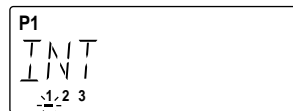

Advance to Interval start day.

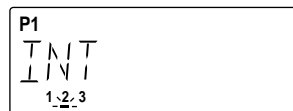

Interval start day selected.
Example: Start Interval tomorrow (2).

Odd Days, Even Days, Or Off Mode

1. Turn the Control Dial to the **WATERING DAYS** position.
2. Program P1 indicator will begin flashing. To select program P2, P3, or P4, press the **+/On** or **-/Off** button until the desired program indicator begins flashing.
3. Press the **Next** button.
 - The current watering day mode (CAL, INT, ODD, EVN or OFF) will begin flashing.
4. Press the **+/On** or **-/Off** button as needed until the desired mode (ODD, EVN or OFF) is flashing.
5. Return the Control Dial to the **AUTO** position.

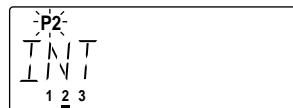

Program 2 selected. Current watering day mode is 3-day interval.

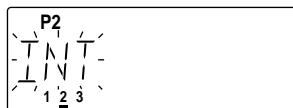

Advance to watering day mode.

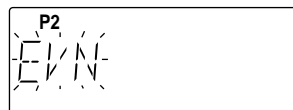

New watering day mode selected.
Example: Even number watering days selected.

Step B - Set Program Start Time(s)

This procedure determines when the program watering cycle will start on a scheduled watering day. Up to six different start times per day can be set for each program, however, only one start time is required to operate a program automatically. When a program watering cycle starts, each station with an assigned run time for that program will operate one at a time in numerical sequence for its run time duration.

Note (for optional Multi-Program operation): When setting program start time(s), remember that two programs can operate simultaneously. If the irrigation system water supply cannot support multiple station operation, schedule start times which enable one program to complete its watering cycle before the next program cycle starts. Also note that any program which starts while two programs are in operation will be delayed until one of the operating programs has completed its watering cycle.

Set program start time(s) as follows:

1. Turn the Control Dial to the **START TIMES** position.
2. Program P1 indicator will begin flashing. To select program P2, P3, or P4, press the **+/On** or **-/Off** button until the desired program indicator begins flashing.
 - Start time numbers 1 – 6 will be displayed. The start time numbers which currently have an assigned start time for this program are underlined.
3. Press the **Next** button.

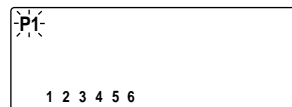

Program 1 selected. No start times currently set for this program.

4. To operate this program in the Slaved mode, press the **+/On** button.
 - On will be displayed.

If the Slaved operation mode is not desired for this program, press the **-/Off** button.

 - Off will be displayed.
5. Press the **Next** button.
 - Start time number 1 will begin flashing.

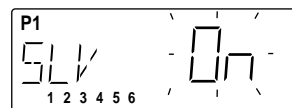

Advance to Slaved control option. Example: Slaved mode On for program 1.

6. Press the **+/On** or **-/Off** button (if needed) to select a different start time number (2 – 6).
 - The currently assigned start time or OFF will be displayed.



Advance to select start time number.

7. Press the **Next** button.
 - The currently assigned start time or OFF will begin flashing.
8. Press the **+/On** or **-/Off** button as needed to display the desired start time or OFF.
 - Press and hold either button for more than three seconds to change the display rapidly.
 - Observe for the correct a.m./p.m. reference. (Applies to 12-hour clock mode only.)
 - For all unused start times, select OFF located between 11:59 p.m. and 12:00 a.m. (23:59 and 0:00).

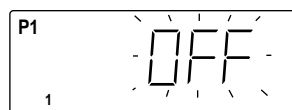

Start time 1 selected. Example: Start time #1 currently Off

9. Press the **Next** button.
 - The next start time number in sequence will begin flashing
10. Repeat steps 6 – 9 to set additional program start times as needed.
11. Return the Control Dial to the **AUTO** position.

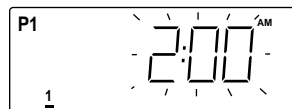

Start time set. Example: start time #1 set for 2:00 AM.

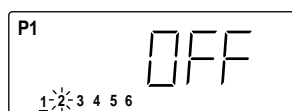

Advance to select next start time number. Example: start time #2 currently Off.

Step C - Set Station Run Time

This procedure determines the length of time each station will operate during a watering program cycle. The number of stations displayed (4, 8, 12 or 16) is automatically determined by the number of 4-station control modules installed. Each station can have a different run time assigned in each program. Run time can be selected from 0 (OFF) to 120 minutes in 1-minute increments or from 2 to 12 hours in 5-minute increments.

A **cycle repeat** option is provided which enables each program watering cycle to operate up to 4 times per start time. When cycle repeat is used, the controller automatically calculates a reduced run time for each station by dividing the amount of run time for each station by the number of repeat cycles selected. In doing this, multiple watering/soak applications can be scheduled without increasing the station run time and total program cycle time. For example: Stations 1 – 4 each have 20 minutes run time assigned in program 1 and the program has been set to cycle 2 times (1 cycle + 1 repeat cycle). When the program watering cycle starts, each station will operate in sequence for 10 minutes. The program cycle will then immediately start over and run each station again for 10 minutes. (20 minutes ÷ 2 cycles = 10 minutes x 2 cycles.)

Set station run time as follows:

1. Turn the Control Dial to the **RUN TIMES** position.
2. Program P1 indicator will begin flashing. To select program P2, P3, or P4, press the **+/On** or **-/Off** button until the desired program indicator begins flashing.
 - All station numbers are displayed. Stations which currently have an assigned run time for the selected program are underlined.
3. Press the **Next** button.
 - CYC (cycle repeat option) will be displayed.
 - The number of cycles (1 – 4) selected for this program will begin flashing.
4. Press the **+/On** or **-/Off** button (if needed) to select the number of repeat cycles desired.
 - 1 = 1 cycle (no repeat) 2 = 1 cycle + 1 repeat
 - 3 = 1 cycle + 2 repeats 4 = 1 cycle + 3 repeats
5. Press the **Next** button.
 - Station number 1 will begin flashing.
6. To select a different station number, press the **+/On** or **-/Off** button until the desired station number is flashing.
 - OFF or the currently assigned run time will be displayed.
7. Press the **Next** button.
 - Only the station number selected will be displayed.
 - OFF or the currently assigned run time will begin flashing.
8. Press the **+/On** or **-/Off** button as needed to display the desired run time or OFF (located between 12:00 and 0:00).
 - Press and hold either button for more than three seconds to change the display rapidly.
 - The display will change in 1-minute increments from 1 minute to 2 hours, and 5-minute increments from 2 to 12 hours.
9. Press the **Next** button.
 - The next station number in sequence will begin flashing.
10. Repeat steps 6 – 9 until all stations to be operational in this program have an assigned run time.
11. Return the Control Dial to the **auto** position.

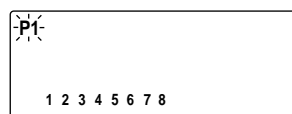

Program 1 selected. Example: 8 stations installed, no assigned run times in program 1.

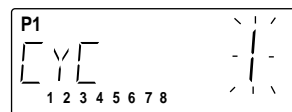

Advance to Cycle Repeat mode. Current setting, 1 cycle - no repeats for program 1.

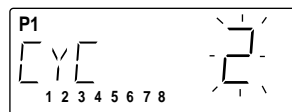

Example: program 1 set for 1 repeat cycle.

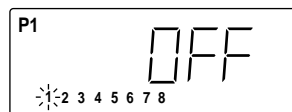

Advance to select station 1.

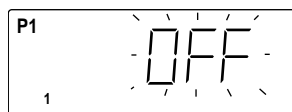

Example; station 1 currently has no run time assigned in program 1.

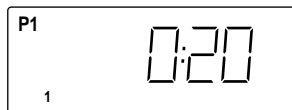

Example; run time for station 1 set for 20 minutes.



Advance to select next station.

Note: This completes the programming steps required to operate a program automatically. Repeat programming procedures A, B and C for each program (P1 – P4) as needed.

Assign Pump / Master Valve Operation

This feature allows the pump/master valve (mv) output to be assigned On or Off as needed for each station. For example, if a station is controlling drip or sub-surface irrigation with a water source which is not pump assisted, pump operation can be automatically disabled when the station begins watering by selecting pump/mv Off. By default, all stations are assigned with pump/mv On. To review and/or change the current station assignments, use the following procedure:

1. Turn the Control Dial to the **ASSIGN PUMP/MV** position.
 - Program indicators P1 – P4 will be displayed.
 - All station numbers will be displayed.
 - Underlined station number indicates pump/mv is operational.
 - Station number 1 will begin flashing. If the station is underlined, On will be displayed; if not underlined, Off will be displayed.
2. Assign pump/mv On or Off for each station as follows:
 - To assign pump/mv **On** for the station number which is flashing, press the **+On** button.
 - The station number is underlined and the next station number will begin flashing.
 - To assign pump/mv **Off** for the station number which is flashing, press the **-Off** button.
 - The underline will disappear and the next station will begin flashing.
3. Repeat step 2 for all stations as needed.
4. Return the Control Dial to the **AUTO** position.

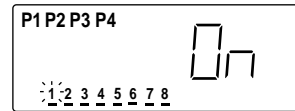

Example: 8 stations installed, all stations assigned pump/mv On. Station 1 selected.

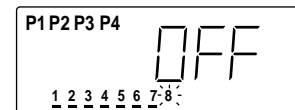

Example: Station 8 assigned pump/mv Off.

Watering Operation Controls

The following manual operation features are provided to enable you to further control the watering programs as necessary once watering activity has begun.

To use these control features, the watering operation must be in progress and the Control Dial must be in the AUTO position.

To pause watering:

Press the **Esc** button **one** time.

- All watering activity will stop.
- The “watering on” symbol will begin flashing
- The display will show the amount of run time remaining for the paused station(s).
- If two programs are operating simultaneously, the display will alternate at 5-second intervals.
- If watering is not resumed within 10 minutes, all watering activity will be canceled. The display will return to the current time and day.

To resume watering (when paused):

Press the **Next** button **one** time.

- All watering activity will resume from the point of interruption.

To cancel watering:

Press the **Esc** button **two** times.

- All watering activity will be canceled until the next automatic or manual operation.
- The display will return to the current time and day.

To advance through watering program(s):

Press the **Next** button **one** time.

- The active station is canceled and the next station in sequence starts.
- Repeating this operation advances through all assigned stations within a program then advances to the next program in sequence.
- Advancing past the last station of the last program terminates the watering operation. The display will return to the current time and day.

To modify station run time:

Press the **+/On** or **-/Off** button to increase or decrease the run time of the currently active station.

- The modified run time will be used during this operation only and will not change the program memory.
- Decreasing the run time to 0:00 will cancel the station operation and advance to the next station in sequence.

Manual Control Operations

The controller can be manually operated whenever additional watering or system operation is required. Three types of manual operations are available: selected station(s), selected program(s) and all programs.

Manual operations utilize the program information which has been entered for automatic operation (with the exception of Cycle Repeat). While operating in the manual mode, watering program information cannot be entered or permanently changed.

Manual operations will override automatic operations. For example, if an automatic watering cycle starts while a manual operation is in progress, the automatic cycle will be delayed until the manual operation has finished. In addition, if an automatic watering cycle is in progress, and a manual operation is started, the automatic cycle will be suspended until the completion of the manual operation. The automatic watering cycle will then resume from the point of interruption.

Note: Additional manual control features become available when a watering operation begins. Refer to “Watering Operation Controls” on page 17 once watering has been started.

To operate selected station(s):

1. Turn Control Dial to **MANUAL** position.
2. Program P1 indicator will begin flashing. To select program P2, P3, or P4, press the **+/On** or **-/Off** button until the desired program indicator begins flashing.
3. Press the **Next** button.
 - The first station number in sequence will begin flashing and its run time will be displayed
4. Select station(s) to operate as follows:
 - To select the station which is flashing, press the **+/On** button.
 - The station number remains underlined and the next station number begins flashing.
 - To skip the station which is flashing, press the **-/Off** button.
 - The underline will disappear and the next station number begins flashing.
5. When all desired stations have been selected, press the **Next** button.
 - The first selected station in numerical sequence will begin watering.
 - The “watering on” symbol will be displayed.
6. Repeat step 2 – 4 (as needed) to select additional stations currently assigned to other programs.

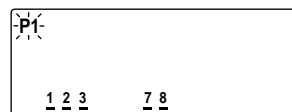

Example: Program 1 selected. Stations 1, 2, 3, 7 & 8 have run time in this program.

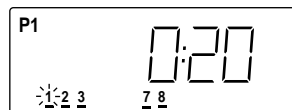

Advance to select stations.

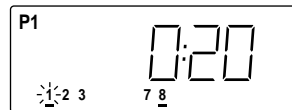

Example: Stations 1 and 8 have been selected to operate.

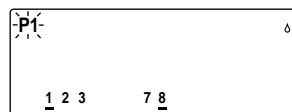

Program 1, station 1 operating.

Note (for optional Multi-Program operation): Only two programs (and stations) can be in operation at the same time. Additional programs will be delayed until one of the operating programs has completed its watering cycle. Programs will operate in the order they were selected.

7. Return the Control Dial to the **AUTO** position.
 - The operating program indicator and station number will begin flashing and the remaining station run time will be displayed.
 - When two programs are in operation, the display information will alternate between operating programs at 5-second intervals.
 - The display will return to the current time and day when all selected stations have completed operation.

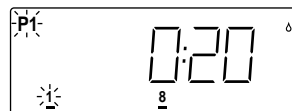

Display after returning Control Dial to Auto position.

Note: To terminate a manual operation and return to the time and day display, **ensure the Control Dial is turned to the AUTO position**, then press the **Esc** button **two** times.

To operate selected program(s):

- Turn the Control Dial to the **MANUAL** position.
 - P1 indicator will begin flashing.
- Press **+ / On** or **- / Off** button (as needed) to select a program number you wish to operate.
 - All station numbers which currently have an assigned run time for the program selected are displayed and underlined.
- Press the **Next** button **two** times to start the program.
 - The “watering on” symbol will be displayed.
 - The program indicator will begin flashing.
- To start additional programs, repeat steps 2 & 3.

Note (for optional Multi-Program operation): Only two programs can be in operation at the same time. Additional programs will be delayed until one of the operating programs has completed its watering cycle. Programs will operate in numerical sequence.

- Return the Control Dial to the **AUTO** position.
 - The operating program indicator and station number will begin flashing and the remaining station run time will be displayed.
 - (For optional Multi-Program operation): If two programs are in operation, the display information will alternate between operating programs at 5-second intervals. See example at right.
 - The display will return to the current time and day when all programs have completed operation.

Note: To terminate the manual operation, **ensure the Control Dial is turned to the AUTO position**, then press the **Esc** button **two** times.

To operate all programs:

- Turn Control Dial to **MANUAL** position.
 - P1 indicator will begin flashing.
- Press the **- / Off** button **one** time to display all four program indicators.
 - All program indicators will begin flashing.
 - All station numbers which currently have an assigned run time are displayed and underlined.
- Press the **Next** button.
 - The “watering on” symbol will be displayed.
 - The watering cycle of the first program in sequence will start.

Note (for optional Multi-Program operation): Only two programs can be in operation at the same time. Additional programs will be delayed until one of the operating programs has completed its watering cycle. Programs will operate in numerical sequence.

- Return the Control Dial to the **AUTO** position.
 - The operating program indicator and station number will begin flashing and the remaining station run time will be displayed.
 - (For optional Multi-Program operation): If two programs are in operation, the display information will alternate between operating programs at 5-second intervals. See example at right.
 - The display will return to the current time and day when all programs have completed operation.

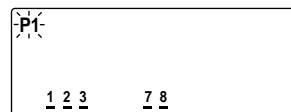

Example: Program 1 selected. Stations 1, 2, 3, 7 & 8 have run time in this program.

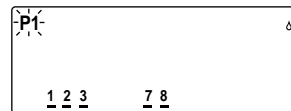

Program 1 started. Station 1 operating.

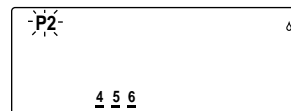

Example: Program 2 started. Stations 4, 5, & 6 have run time in this program.

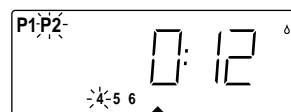

Display after returning Control Dial to Auto. Both programs operating. Program 2, station 4 On, 12 minutes run time remaining.

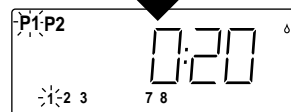

Program 1, station 1 On, 20 minutes run time remaining.

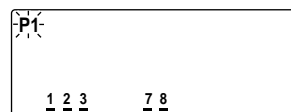

Example: Program 2 started. Stations 4, 5, & 6 have run time in this program.

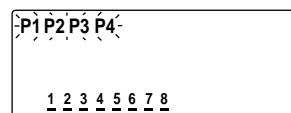

Example: Program 2 started. Stations 4, 5, & 6 have run time in this program.

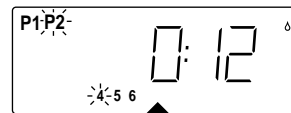

Both programs operating. Program 2, station 4 On, 12 minutes run time remaining.

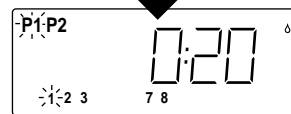

Program 1, station 1 On, 20 minutes run time remaining.

Season Adjust

A change in season generally requires an adjustment in station run time to prevent under or over watering. The Program Adjust and Global Adjust features enable you to easily decrease station run times down to 10% of normal for operation during cooler months, or increase the run times up to 250% during warmer months, without reprogramming. The set run time for each station is retained in memory and can be returned by setting the adjustment value back to 100%.

Program Adjust modifies the run times of all stations within selected programs. Global Adjust is used to modify the station run times of all programs. Both types of adjustments apply to automatic and manual operations.

Note: The percentage values of Program Adjust and Global Adjust are both applied to the station run times. For example: A 20 minute station run time decreased by a 50% Program Adjust value would produce a 10 minute adjusted run time. If a 50% Global Adjust value is also used, the adjusted run time would be decreased by an additional 50% to provide a 5 minute run time.

Program Adjust

1. Turn the Control Dial to the **PROGRAM ADJUST** position.
2. Program P1 indicator will begin flashing. To select program P2, P3, or P4, press the **+/On** or **-/Off** button until the desired program indicator begins flashing.
 - The current adjustment percentage value for the program selected will be displayed.
3. Press the **Next** button.
 - The percentage value will begin flashing.
4. Press the **+/On** or **-/Off** button to increase or decrease the percentage value as needed.
 - Press and hold either button for more than three seconds to change the display rapidly.
5. Return the Control Dial to the **AUTO** position.



Program 1 selected. Example: Program 1 current setting is 100%.

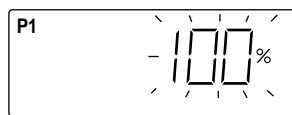

Advance to select percentage value.

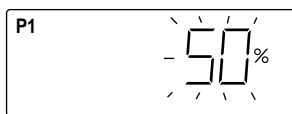

Example: Program 1 station run time decreased to 50%.

Note: The adjusted station run time is displayed only during a watering operation.

Global Adjust

1. Turn the Control Dial to **GLOBAL ADJUST** position.
 - Program indicators P1 – P4 will be displayed.
 - The current global adjustment value will be displayed.
2. Press the **+/On** or **-/Off** button to display the desired percentage.
 - Press and hold either button for more than three seconds to change the display rapidly.
3. Return the Control Dial to the **AUTO** position.

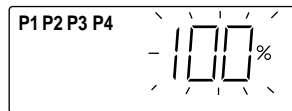

Program 1 selected. Example: Global adjust currently set to 100%.

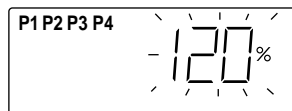

Example: Global adjust run time value increased to 120%.

Note: The adjusted station run time is displayed only during a watering operation.

Off and Rain Delay Modes

This feature enables all automatic watering programs to be suspended indefinitely in the Off mode or for a specified period of time from 1 to 7 days in the Rain Delay mode.

When the Off mode is selected, all automatic operation is suspended. The word OFF and the flashing “no watering” symbol are displayed for approximately 10 minutes. The display then reverts to the current time and day, however, no watering will occur and the Off mode will be maintained until the Control Dial is moved from the Rain Delay position.

The Rain Delay mode will temporarily suspend all automatic operation from 1 to 7 days as selected. At the 12:00 a.m. (0:00) day change, the rain delay number will automatically decrease by one digit. When the rain delay number decreases to 0 (zero), automatic operation will resume as scheduled.

Off Mode

1. Turn the Control Dial to the **OFF / RAIN DELAY** position.
 - OFF will be displayed and the “no watering” symbol will begin flashing.
 - In approximately 10 minutes, the display will revert to current time and day.

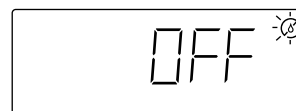

Off mode selected.

Note: To terminate the Off mode, return the Control Dial to the **AUTO** position.

Rain Delay Mode

1. Turn the Control Dial to the **OFF / RAIN DELAY** position.
 - OFF will be displayed and the “no watering” symbol will begin flashing.
2. Press the **+ / On** button one time to select Rain Delay mode.
 - DLY and a 1-day delay number will be displayed for 3 seconds.
3. To change the number of Rain Delay days (2 – 7), press the **+ / On** or **- / Off** button as needed.

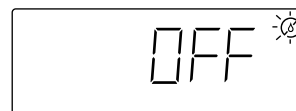

Off mode is selected first.

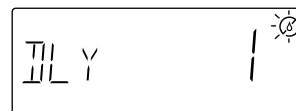

Advance to Rain Delay mode. Watering suspended 1 day.

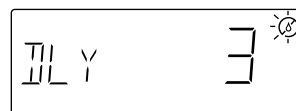

Example: watering delayed for 3 days.

Note: After 3 seconds, the display will begin alternating between the Rain Delay information and the current time and day. If you wish to change the number of Rain Delay days, repeat step 3 while the rain delay information is being displayed.



Display will begin alternating between Rain Delay information and current time.

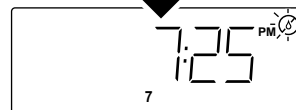

Note: To terminate the Rain Delay mode, return the Control Dial to the **AUTO** position.

Station Control Modules

Installing A Control Module

1. Turn Control Dial to **OFF/RAIN DELAY** position to place controller in the Off mode.

Note: When installing additional station control modules, ALWAYS use the first available expansion slot from top to bottom. The controller will recognize an open expansion slot between station control modules as having a module installed, giving a false station count.

2. Slide locking tab (located directly above module to be removed) to the left (release position). Carefully install control module against inside back wall of cabinet between guide rails, about 1" (25 mm) away from PCB. Slide module to the left engaging guide rails, white plastic receptacle and metal clip. Slide locking tab to the right to the lock position. See **Figure 13**.

Note: When correctly installed, the module will be secured between guide rails and flush against the PCB.

3. **Wait 10 seconds** for controller to acquire new station count. Turn Control Dial to **AUTO** position.
4. Refer to "Connecting Control Valves" on page 5 to install valve wiring.
5. Refer to "Set Station Run Time" on page 15 to program new station run time(s).
6. Refer to "Running A Test Cycle" on page 9 to test automatic operation of new stations.

Figure 13

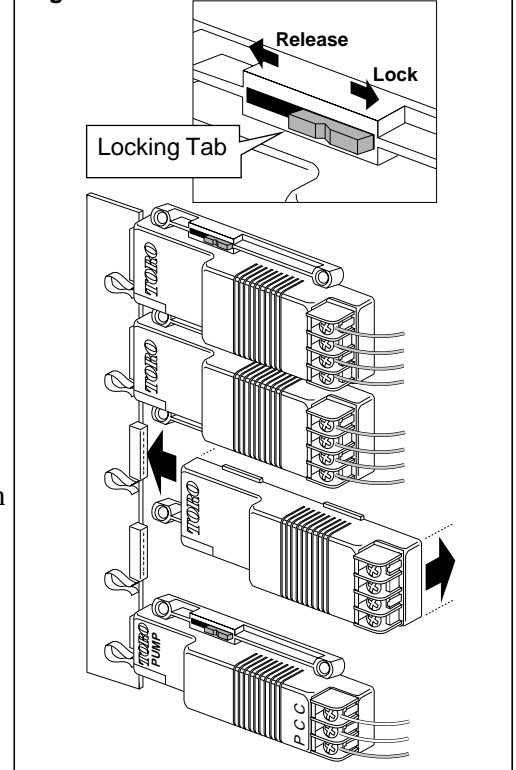

Removing A Control Module

1. Turn Control Dial to **OFF/RAIN DELAY** position to place controller in the Off mode.
2. Remove valve control wires from terminal block, or remove terminal block from control module.
3. Slide locking tab (located directly above module to be removed) to the left (release position). Slide control module carefully to the right, disengaging it from PCB receptacles and slotted openings in guide rails. See **Figure 14**.
4. **Wait 10 seconds** for controller to acquire new station count. Turn Control Dial to **AUTO** position.

Figure 14

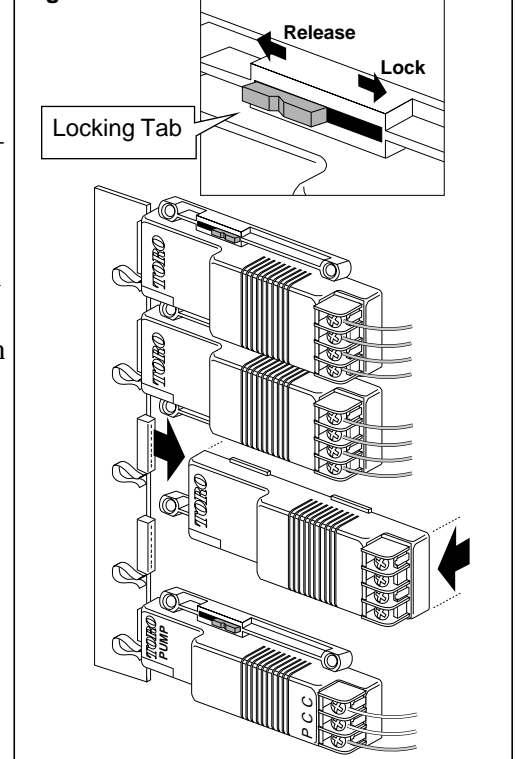

Program Planning Chart

Program Number - P

Watering Days Su Mo Tu We Th Fr Sa Su Mo Tu We Th Fr Sa
 Calendar Interval 1 2 3 4 5 6 7 8 9 10 11 12 13 14 Odd Days Even Days Off

Program Cycle Start Times Slaved Operation Mode - Off On
 1 ___:___^{a.m.}/_{p.m.} Off 2 ___:___^{a.m.}/_{p.m.} Off 3 ___:___^{a.m.}/_{p.m.} Off 4 ___:___^{a.m.}/_{p.m.} Off 5 ___:___^{a.m.}/_{p.m.} Off 6 ___:___^{a.m.}/_{p.m.} Off

Station Run Time Cycle Repeat - 1 (no repeats) 2 (1 repeat) 3 (2 repeats) 4 (3 repeats)
Sta. 1 ___ hrs. ___ min. Off **Sta. 5** ___ hrs. ___ min. Off **Sta. 9** ___ hrs. ___ min. Off **Sta. 13** ___ hrs. ___ min. Off
Sta. 2 ___ hrs. ___ min. Off **Sta. 6** ___ hrs. ___ min. Off **Sta. 10** ___ hrs. ___ min. Off **Sta. 14** ___ hrs. ___ min. Off
Sta. 3 ___ hrs. ___ min. Off **Sta. 7** ___ hrs. ___ min. Off **Sta. 11** ___ hrs. ___ min. Off **Sta. 15** ___ hrs. ___ min. Off
Sta. 4 ___ hrs. ___ min. Off **Sta. 8** ___ hrs. ___ min. Off **Sta. 12** ___ hrs. ___ min. Off **Sta. 16** ___ hrs. ___ min. Off

Program Number - P

Watering Days Su Mo Tu We Th Fr Sa Su Mo Tu We Th Fr Sa
 Calendar Interval 1 2 3 4 5 6 7 8 9 10 11 12 13 14 Odd Days Even Days Off

Program Cycle Start Times Slaved Operation Mode - Off On
 1 ___:___^{a.m.}/_{p.m.} Off 2 ___:___^{a.m.}/_{p.m.} Off 3 ___:___^{a.m.}/_{p.m.} Off 4 ___:___^{a.m.}/_{p.m.} Off 5 ___:___^{a.m.}/_{p.m.} Off 6 ___:___^{a.m.}/_{p.m.} Off

Station Run Time Cycle Repeat - 1 (no repeats) 2 (1 repeat) 3 (2 repeats) 4 (3 repeats)
Sta. 1 ___ hrs. ___ min. Off **Sta. 5** ___ hrs. ___ min. Off **Sta. 9** ___ hrs. ___ min. Off **Sta. 13** ___ hrs. ___ min. Off
Sta. 2 ___ hrs. ___ min. Off **Sta. 6** ___ hrs. ___ min. Off **Sta. 10** ___ hrs. ___ min. Off **Sta. 14** ___ hrs. ___ min. Off
Sta. 3 ___ hrs. ___ min. Off **Sta. 7** ___ hrs. ___ min. Off **Sta. 11** ___ hrs. ___ min. Off **Sta. 15** ___ hrs. ___ min. Off
Sta. 4 ___ hrs. ___ min. Off **Sta. 8** ___ hrs. ___ min. Off **Sta. 12** ___ hrs. ___ min. Off **Sta. 16** ___ hrs. ___ min. Off

Program Number - P

Watering Days Su Mo Tu We Th Fr Sa Su Mo Tu We Th Fr Sa
 Calendar Interval 1 2 3 4 5 6 7 8 9 10 11 12 13 14 Odd Days Even Days Off

Program Cycle Start Times Slaved Operation Mode - Off On
 1 ___:___^{a.m.}/_{p.m.} Off 2 ___:___^{a.m.}/_{p.m.} Off 3 ___:___^{a.m.}/_{p.m.} Off 4 ___:___^{a.m.}/_{p.m.} Off 5 ___:___^{a.m.}/_{p.m.} Off 6 ___:___^{a.m.}/_{p.m.} Off

Station Run Time Cycle Repeat - 1 (no repeats) 2 (1 repeat) 3 (2 repeats) 4 (3 repeats)
Sta. 1 ___ hrs. ___ min. Off **Sta. 5** ___ hrs. ___ min. Off **Sta. 9** ___ hrs. ___ min. Off **Sta. 13** ___ hrs. ___ min. Off
Sta. 2 ___ hrs. ___ min. Off **Sta. 6** ___ hrs. ___ min. Off **Sta. 10** ___ hrs. ___ min. Off **Sta. 14** ___ hrs. ___ min. Off
Sta. 3 ___ hrs. ___ min. Off **Sta. 7** ___ hrs. ___ min. Off **Sta. 11** ___ hrs. ___ min. Off **Sta. 15** ___ hrs. ___ min. Off
Sta. 4 ___ hrs. ___ min. Off **Sta. 8** ___ hrs. ___ min. Off **Sta. 12** ___ hrs. ___ min. Off **Sta. 16** ___ hrs. ___ min. Off

Program Number - P

Watering Days Su Mo Tu We Th Fr Sa Su Mo Tu We Th Fr Sa
 Calendar Interval 1 2 3 4 5 6 7 8 9 10 11 12 13 14 Odd Days Even Days Off

Program Cycle Start Times Slaved Operation Mode - Off On
 1 ___:___^{a.m.}/_{p.m.} Off 2 ___:___^{a.m.}/_{p.m.} Off 3 ___:___^{a.m.}/_{p.m.} Off 4 ___:___^{a.m.}/_{p.m.} Off 5 ___:___^{a.m.}/_{p.m.} Off 6 ___:___^{a.m.}/_{p.m.} Off

Station Run Time Cycle Repeat - 1 (no repeats) 2 (1 repeat) 3 (2 repeats) 4 (3 repeats)
Sta. 1 ___ hrs. ___ min. Off **Sta. 5** ___ hrs. ___ min. Off **Sta. 9** ___ hrs. ___ min. Off **Sta. 13** ___ hrs. ___ min. Off
Sta. 2 ___ hrs. ___ min. Off **Sta. 6** ___ hrs. ___ min. Off **Sta. 10** ___ hrs. ___ min. Off **Sta. 14** ___ hrs. ___ min. Off
Sta. 3 ___ hrs. ___ min. Off **Sta. 7** ___ hrs. ___ min. Off **Sta. 11** ___ hrs. ___ min. Off **Sta. 15** ___ hrs. ___ min. Off
Sta. 4 ___ hrs. ___ min. Off **Sta. 8** ___ hrs. ___ min. Off **Sta. 12** ___ hrs. ___ min. Off **Sta. 16** ___ hrs. ___ min. Off

Program Planning Chart

Program Number - P

Watering Days Su Mo Tu We Th Fr Sa Su Mo Tu We Th Fr Sa
 Calendar Interval 1 2 3 4 5 6 7 8 9 10 11 12 13 14 Odd Days Even Days Off

Program Cycle Start Times Slaved Operation Mode - Off On
 1 ___:___^{a.m.}/_{p.m.} Off 2 ___:___^{a.m.}/_{p.m.} Off 3 ___:___^{a.m.}/_{p.m.} Off 4 ___:___^{a.m.}/_{p.m.} Off 5 ___:___^{a.m.}/_{p.m.} Off 6 ___:___^{a.m.}/_{p.m.} Off

Station Run Time Cycle Repeat - 1 (no repeats) 2 (1 repeat) 3 (2 repeats) 4 (3 repeats)
Sta. 1 ___ hrs. ___ min. Off **Sta. 5** ___ hrs. ___ min. Off **Sta. 9** ___ hrs. ___ min. Off **Sta. 13** ___ hrs. ___ min. Off
Sta. 2 ___ hrs. ___ min. Off **Sta. 6** ___ hrs. ___ min. Off **Sta. 10** ___ hrs. ___ min. Off **Sta. 14** ___ hrs. ___ min. Off
Sta. 3 ___ hrs. ___ min. Off **Sta. 7** ___ hrs. ___ min. Off **Sta. 11** ___ hrs. ___ min. Off **Sta. 15** ___ hrs. ___ min. Off
Sta. 4 ___ hrs. ___ min. Off **Sta. 8** ___ hrs. ___ min. Off **Sta. 12** ___ hrs. ___ min. Off **Sta. 16** ___ hrs. ___ min. Off

Program Number - P

Watering Days Su Mo Tu We Th Fr Sa Su Mo Tu We Th Fr Sa
 Calendar Interval 1 2 3 4 5 6 7 8 9 10 11 12 13 14 Odd Days Even Days Off

Program Cycle Start Times Slaved Operation Mode - Off On
 1 ___:___^{a.m.}/_{p.m.} Off 2 ___:___^{a.m.}/_{p.m.} Off 3 ___:___^{a.m.}/_{p.m.} Off 4 ___:___^{a.m.}/_{p.m.} Off 5 ___:___^{a.m.}/_{p.m.} Off 6 ___:___^{a.m.}/_{p.m.} Off

Station Run Time Cycle Repeat - 1 (no repeats) 2 (1 repeat) 3 (2 repeats) 4 (3 repeats)
Sta. 1 ___ hrs. ___ min. Off **Sta. 5** ___ hrs. ___ min. Off **Sta. 9** ___ hrs. ___ min. Off **Sta. 13** ___ hrs. ___ min. Off
Sta. 2 ___ hrs. ___ min. Off **Sta. 6** ___ hrs. ___ min. Off **Sta. 10** ___ hrs. ___ min. Off **Sta. 14** ___ hrs. ___ min. Off
Sta. 3 ___ hrs. ___ min. Off **Sta. 7** ___ hrs. ___ min. Off **Sta. 11** ___ hrs. ___ min. Off **Sta. 15** ___ hrs. ___ min. Off
Sta. 4 ___ hrs. ___ min. Off **Sta. 8** ___ hrs. ___ min. Off **Sta. 12** ___ hrs. ___ min. Off **Sta. 16** ___ hrs. ___ min. Off

Program Number - P

Watering Days Su Mo Tu We Th Fr Sa Su Mo Tu We Th Fr Sa
 Calendar Interval 1 2 3 4 5 6 7 8 9 10 11 12 13 14 Odd Days Even Days Off

Program Cycle Start Times Slaved Operation Mode - Off On
 1 ___:___^{a.m.}/_{p.m.} Off 2 ___:___^{a.m.}/_{p.m.} Off 3 ___:___^{a.m.}/_{p.m.} Off 4 ___:___^{a.m.}/_{p.m.} Off 5 ___:___^{a.m.}/_{p.m.} Off 6 ___:___^{a.m.}/_{p.m.} Off

Station Run Time Cycle Repeat - 1 (no repeats) 2 (1 repeat) 3 (2 repeats) 4 (3 repeats)
Sta. 1 ___ hrs. ___ min. Off **Sta. 5** ___ hrs. ___ min. Off **Sta. 9** ___ hrs. ___ min. Off **Sta. 13** ___ hrs. ___ min. Off
Sta. 2 ___ hrs. ___ min. Off **Sta. 6** ___ hrs. ___ min. Off **Sta. 10** ___ hrs. ___ min. Off **Sta. 14** ___ hrs. ___ min. Off
Sta. 3 ___ hrs. ___ min. Off **Sta. 7** ___ hrs. ___ min. Off **Sta. 11** ___ hrs. ___ min. Off **Sta. 15** ___ hrs. ___ min. Off
Sta. 4 ___ hrs. ___ min. Off **Sta. 8** ___ hrs. ___ min. Off **Sta. 12** ___ hrs. ___ min. Off **Sta. 16** ___ hrs. ___ min. Off

Program Number - P

Watering Days Su Mo Tu We Th Fr Sa Su Mo Tu We Th Fr Sa
 Calendar Interval 1 2 3 4 5 6 7 8 9 10 11 12 13 14 Odd Days Even Days Off

Program Cycle Start Times Slaved Operation Mode - Off On
 1 ___:___^{a.m.}/_{p.m.} Off 2 ___:___^{a.m.}/_{p.m.} Off 3 ___:___^{a.m.}/_{p.m.} Off 4 ___:___^{a.m.}/_{p.m.} Off 5 ___:___^{a.m.}/_{p.m.} Off 6 ___:___^{a.m.}/_{p.m.} Off

Station Run Time Cycle Repeat - 1 (no repeats) 2 (1 repeat) 3 (2 repeats) 4 (3 repeats)
Sta. 1 ___ hrs. ___ min. Off **Sta. 5** ___ hrs. ___ min. Off **Sta. 9** ___ hrs. ___ min. Off **Sta. 13** ___ hrs. ___ min. Off
Sta. 2 ___ hrs. ___ min. Off **Sta. 6** ___ hrs. ___ min. Off **Sta. 10** ___ hrs. ___ min. Off **Sta. 14** ___ hrs. ___ min. Off
Sta. 3 ___ hrs. ___ min. Off **Sta. 7** ___ hrs. ___ min. Off **Sta. 11** ___ hrs. ___ min. Off **Sta. 15** ___ hrs. ___ min. Off
Sta. 4 ___ hrs. ___ min. Off **Sta. 8** ___ hrs. ___ min. Off **Sta. 12** ___ hrs. ___ min. Off **Sta. 16** ___ hrs. ___ min. Off

Troubleshooting

If a system malfunction occurs, check the list of possible problems, causes and remedies. If the problem cannot be resolved, please contact your local Toro installer.

Problem	Probable Cause	Remedy
Valves will not turn on.	Output circuit breaker tripped. Loose module or terminal block connection.	Check for probable cause, i.e., faulty wire splices, or excessive current draw on station output terminal(s). Press circuit breaker button to reset. Check and secure module and/or terminal block.
Controller display shows incorrect number of stations installed.	Station control module(s) installed incorrectly.	Check installation of station control modules. Station modules must be installed from top position down without open slots.
Watering program(s) start at unscheduled times.	Clock and calendar not set to current time and date. Overlapping programs causing start time delays. Increased station run times due to increased Season Adjust value.	Set clock and calendar to current time and date. Check watering program schedules and adjust start times and/or station run times as necessary. Check Season Adjust values and decrease or reset to 100%.
Valve will not turn off.	Control valve malfunction.	Inspect, clean or replace valve solenoid/plunger assembly.

Quick Reference Guide

Use this guide as a memory jogger once you are thoroughly familiar with the XF - 416 programming and operating procedures detailed within this manual. For ready reference, place the manual on the inside of the cabinet cover with this page facing out.

Watering Operation Controls

To use these control features, watering must be in progress and the Control Dial must set to **Auto**.

To PAUSE watering:

Press **Esc** one time.

To resume watering (when paused):

Press **Next** one time.

To CANCEL watering:

Press **Esc** two times.

To advance through watering program(s):

Press **Next** one time.

To modify station run time:

Press **+/On** or **-/Off** to modify run time of operating station.

Manual Operations

To operate selected station(s):

1. Turn Control Dial to **MANUAL**.
2. Press **+/On** or **-/Off** to select program #. Press **Next**.
3. •To select station number, press **+/On**.
•To skip station number, press **-/Off**.
4. When all desired stations are underlined, press **Next**.
5. Repeat step 2 & 3 (if needed) to select additional stations currently assigned to other programs.
6. Turn Control Dial to **AUTO**.

To operate selected program(s):

1. Turn Control Dial to **MANUAL**.
2. Press **+/On** or **-/Off** to select program #.
3. Press **Next** two times to start program.
4. To start additional programs, repeat steps 2 & 3.
5. Turn Control Dial to **AUTO** position.

To operate all programs:

1. Turn Control Dial to **MANUAL**.
2. Press **-/Off** button one time to display P1 – P4.
3. Press **Next** to start first program in numerical order.
4. Turn Control Dial to **AUTO**.

Program Adjust

1. Turn Control Dial to **PROGRAM ADJUST**.
2. Press **+/On** or **-/Off** to select program #. Press **Next**.
3. Press **+/On** or **-/Off** to adjust station run time (10% – 250%).
4. Turn Control Dial to **AUTO**.

Global Adjust

1. Turn Control Dial to **GLOBAL ADJUST**.
2. Press **+/On** or **-/Off** to adjust station run time (10% – 250%).
3. Turn Control Dial to **AUTO**.

To Set or Review Clock Time and Date:

1. Turn Control Dial to **TIME & DATE**.
2. Press **+/On** or **-/Off** to set current time. Press **Next**.
3. Press **+/On** or **-/Off** to set current month. Press **Next**.
4. Press **+/On** or **-/Off** to set current day. Press **Next**.
5. Press **+/On** or **-/Off** to set current year. Press **Next**.
6. Press **+/On** or **-/Off** to set current week (1 or 2).
7. Turn Control Dial to **AUTO**.

To Set or Review Program Watering Day Schedule

• Calendar Schedule

1. Turn Control Dial to **WATERING DAYS**.
2. Press **+/On** or **-/Off** to select program #. Press **Next**.
3. Press **+/On** or **-/Off** to select **CALendar**. Press **Next**.
4. •To select day number, press **+/On**.
•To skip day number, press **-/Off**.
5. Repeat step 6 to set all 14 days as needed.
6. Turn Control Dial to **AUTO**.

• Interval Schedule

1. Turn Control Dial to **WATERING DAYS**.
2. Press **+/On** or **-/Off** to select program #. Press **Next**.
3. Press **+/On** or **-/Off** to select **INTerval**. Press **Next**.
4. Press **+/On** or **-/Off** to set interval # (1 – 14). Press **Next**.
5. Press **+/On** or **-/Off** to underline interval start day.
6. Turn Control Dial to **AUTO** position.

• Odd Days, Even Days, Or Off Mode

1. Turn Control Dial to **WATERING DAYS**.
2. Press **+/On** or **-/Off** to select program #. Press **Next**.
3. Press **+/On** or **-/Off** to select **ODD**, **EVN** or **OFF**.
4. Turn Control Dial to **AUTO**.

To Set or Review Program Start Times:

1. Turn Control Dial to **START TIMES**.
2. Press **+/On** or **-/Off** to select program #. Press **Next**.
3. Press **+/On** or **-/Off** to set Slaved mode. Press **Next**.
4. Press **+/On** or **-/Off** to select start time #. Press **Next**.
5. Press **+/On** or **-/Off** to set start time or Off. Press **Next**.
6. Repeat steps 4 & 5 to set additional program start times.
7. Turn Control Dial to **AUTO** position.

To Set or Review Station Run Times:

1. Turn Control Dial to **RUN TIMES**.
2. Press **+/On** or **-/Off** to select program #. Press **Next**.
3. Press the **+/On** or **-/Off** to select # of program cycles (1 = 0 repeats – 4 = 3 repeats). Press **Next**.
4. Press **+/On** or **-/Off** to select station #. Press **Next**.
5. Press **+/On** or **-/Off** to set run time or Off. Press **Next**.
6. Repeat steps 4 & 5 for all stations as needed.
7. Turn Control Dial to **AUTO** position.